

Vacuum Ovens VO



100°

90°

80°

70°

60°

50°

40°

30°

20°

10°

*From orange juice to electronic chips –
vacuum technology protects heat-sensitive materials*

*A class by itself:
sensors and heating directly on the load*

*Programmable vacuum cycles
for accelerated moisture extraction*

Multitasking in vacuum

Minimal heating times

Turbo drying

>>>> www.memmert.com



Strong as a team: VO plus pump module and pump

The VO oven together with pump module and pump forms an exceptionally energy-saving combination. The vacuum pump switches off automatically when the vacuum is reached and only switches back on when required.

Flexibility features in vacuum technology

In drying cosmetics, foodstuffs, jewellery, watches or injection moulds, in encapsulating semiconductor modules under exclusion of air – science and industry make use of the characteristic physical properties of a vacuum:

- Gentle treatment of heat-sensitive substances and complete removal of residual moisture on components with complex geometry through reduction of the boiling point of water in vacuum (e.g. 46°C at 100 mbar)
- No air movement because of the absence of air and oxygen in vacuum, no oxidation, no air inclusions in the material
- No contamination of the oven load because of the closed system

A gentle power package

Short heating times, precise temperature control and turbo-drying demonstrate the full power of the Memmert vacuum ovens VO – and their handling of heat- and oxygen-sensitive substances and materials is exceptionally gentle. Adjustable temperatures from 20°C to 200°C together with a pressure range from 10 mbar to 1100 mbar produce ideal conditions for a wide range of applications. As accessory to the vacuum oven, Memmert supply a specially developed controllable pump which can be installed in the pump module – a matching cabinet for mounting below the vacuum oven.

3 sizes: 29 - 49 - 101 litre chamber volume

Noble design with a strong character

The electropolished chamber of the oven as well as the extra internal panels (dismountable for cleaning) are made from high-grade and completely recyclable stainless steel Ref. 1.4404. Specially smooth and hygienic surfaces simplify cleaning without leaving any residue and very largely prevent contamination of the oven load.

The outer casing is made from sturdy textured stainless steel (back panel in zinc-plated sheet steel) and conforms to Memmert's holistic quality philosophy.

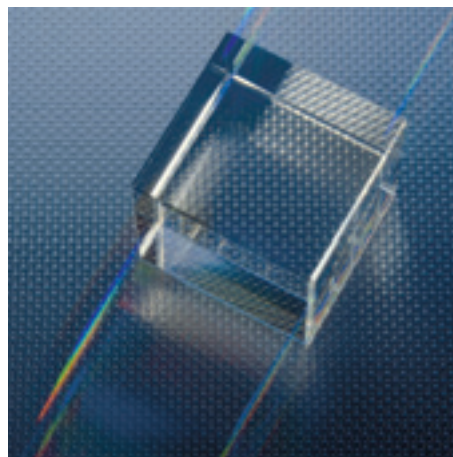

Convenience: made for you!

The vacuum oven is easy to use:

- Clear, easy-to-clean underglass function display with simultaneous visualisation of all parameters such as pressure and temperature
- Memmert's unique feature: the push-turn control (patent applied for) permits intuitive selection from the entire menu
- Each thermoshelf in contact has its own heating symbol in the function display
- Actual temperature of each shelf can be called up
- Weekly programme timer with real-time clock
- Ramp timer
- Digital indication of actual pressure
- Additional internal stainless steel panels, removable for cleaning
- Rapid venting for opening the door, reactivated continuation of the programme
- Two programmable connections for air and inert gas with digital control

Potential savings at all levels!

Volume-optimised temperature control and direct heating of the thermoshelves make the vacuum oven a world beater in saving time and energy. Maximum security and reliability are guaranteed by an all-round "carefree" package for programming and documentation.

An operating record

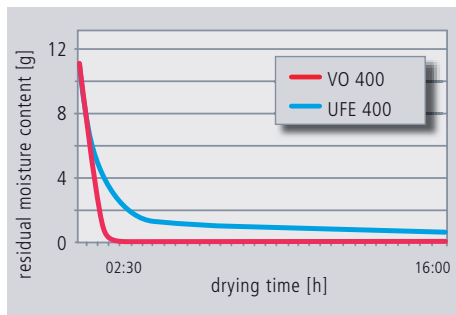

Modules with electronic and electromechanical components must not be dried above 70 °C after washing. Compared with forced air circulation ovens, a vacuum oven requires about two-third less energy and only about one-sixth of the processing time for the same drying process!

A further and convincing unique feature of vacuum technology: to achieve zero residual moisture.

Multi-level heating (MLH)

Each of the up to four plug-in stainless steel thermoshelves is provided with a large-area heating as well as its own sensor (Multi-Level Sensing MLS). The individual control circuits respond precisely to differences in loading and moisture content and keep all the used levels evenly at the selected set temperature. Because of the direct contact between heating and load there is virtually no heat loss and the heating-up and operating times are reduced by about 75 percent compared with conventional inner wall heating.

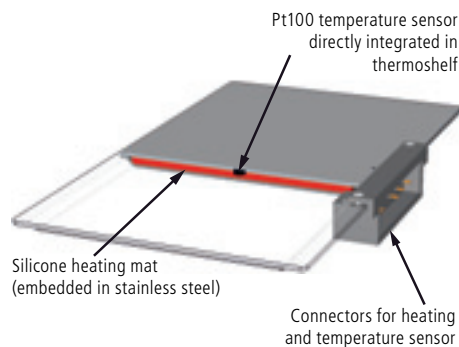

Removable thermoshelf with direct heating and sensor

Repeat function with turbo effect

The vacuum oven leaves the user a lot of time for essentials: User-friendly ramp programming saves effort and ensures reliable process sequences. Up to 40 ramps with different temperature and vacuum setpoints can be programmed either directly on the controller or using the MEMory-Card. The "Celsius" software which is part of the standard specification provides a practically unlimited number of ramps.

Programming of vacuum cycles produces a further appreciable shortening of the drying time.

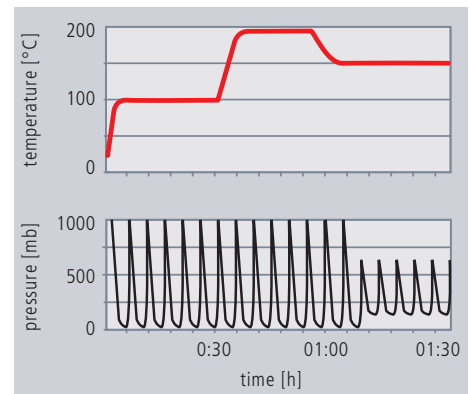

Even under pressure – secure and reliable!



Precision: for controlled procedures

Technical features for faultless processes:

- Multifunctional fuzzy-supported control for accurate setting and maintenance of temperature and pressure
- Multi-Level Control (MLC): Pt100 sensor in 4-wire circuit integral with each thermoshelf for setpoint control and individually selectable temperature indication
- Digitised electronic vacuum control 10 to 1100 mbar through solenoid valves, setting accuracy 1 mbar. Additional adjustment "LO" for operation below 10 mbar on the final pump vacuum
- Programme run is delayed until the set temperature and/or pressure have been reached
- The electronic controller optimises the efficiency of the vacuum pump through demand-controlled purge action of the pump diaphragm
- Calibration facility for temperature and pressure directly on the controller
- Option (extra charge): flexible Pt100 sensors for external temperature recording, freely positionable in the chamber or on the load

Security: of course!

Yet more functions for zero error:

- Integral auto-diagnostic system with visual and acoustic indication
- Multiple temperature monitor with mechanical temperature limiter TB, adjustable electronic temperature monitor TWW, Memmert ASF (Automatic Safety Function) for minimum and maximum values as well as multi-level over-temperature protection (MLOP); gliding over-temperature protection automatically following the setpoint, the heating on the appropriate thermoshelf is switched off in case of a fault
- Acoustic signal report on over/undertemperature
- Protection against unauthorised operation: optional oven-linked personal User-ID-Card (extra charge)

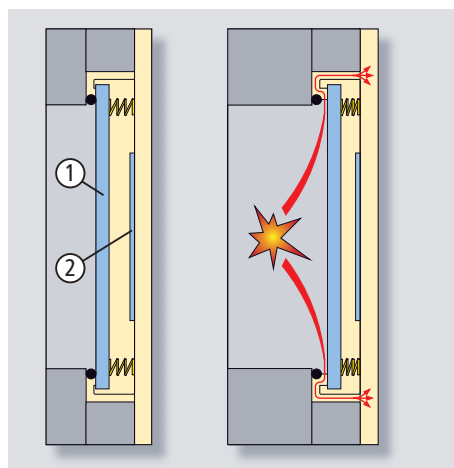

Special full-view glass door, 15 mm thick safety glass (1) spring-loaded internally, outer face with anti-splinter screen (2). Any sudden overpressure is relieved as the safety glass panel springs back

Documentation: for controlled quality

The basic specification for professional quality control:

- Standard "Celsius" software for programming and documentation; optional FDA-conforming software (extra charge)
- Internal ring memory for continuous long-term documentation fully protected against manipulation (approx. 3 months)
- MEMoryCard XL for programming up to 40 temperature and pressure ramps and documentation of temperature processes
- RS232 interface (RS485 option without extra charge) for programming and storage, also printer interface for printing temperature processes



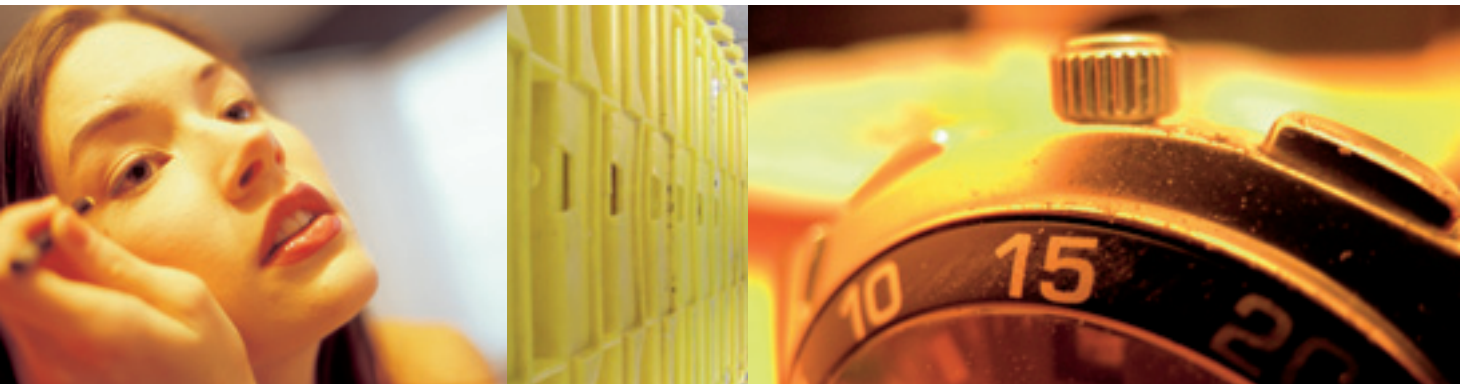

Timer module

- 1 time indication (here real-time)
- 2 text messages

Temperature module

- 22 thermoshelf indication (in contact)
- 23 heating indicator, separate for each thermoshelf
- 24 setpoint/actual temperature
 - temperature adjustment: +20°C to +200°C
 - variation (time): +/- 0.3°C max.
 - uniformity (surface): +/- 5°C max. at 160°C/50 mbar

Monitor module

- 25 visual alarm
- 26 alarm limit
- 27 temperature limiter
- 28 LOW alarm limit
- 29 automatic alarm limit (ASF)
- 30 HIGH alarm limit
- 31 sounder on alarm

Acoustic and visual alarm on over/undertemperature and other error messages

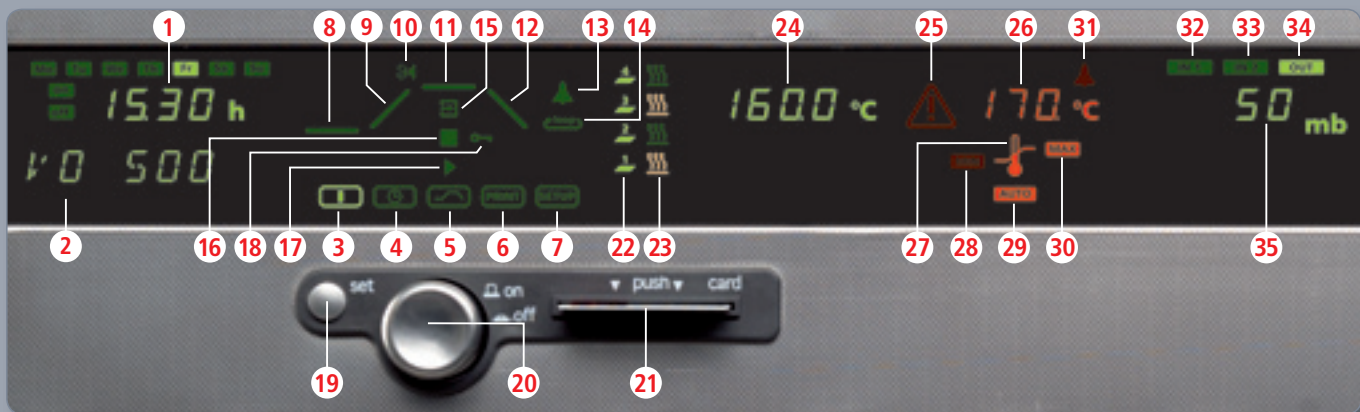

Operating mode

- 3 normal operation (active)
- 4 weekly timer*
- 5 ramp timer (relative-time programme)
- 6 printer
- 7 configuration
- 8 wait (at programme start), hold (during programme)
- 9 heating ramp
- 10 setpoint wait – programme continues when setpoint is reached
- 11 hold ramp
- 12 cooling ramp
- 13 sounder at ramp timer end

- 14 repeat function
- 15 edit
- 16 stop (ramp timer)
- 17 start (ramp timer)
- 18 manipulation prevented through optional User-ID-Card (extra charge)
- 19 SET key
- 20 push/turn control
- 21 chip card reader for MEMoryCard and optional User-ID-Card (extra charge)

* weekly timer, programmable with one ON and OFF time per weekday; additional group function (e.g. every working day)

Vacuum module

- 32 inlet valve (fresh air)
- 33 inlet valve (inert gas)
- 34 outlet valve vacuum (active)
- 35 vacuum setpoint/actual

Technical data, models and accessories for Vacuum Ovens VO

Interfaces:



Dimensions of Vacuum Ovens
(see table below)

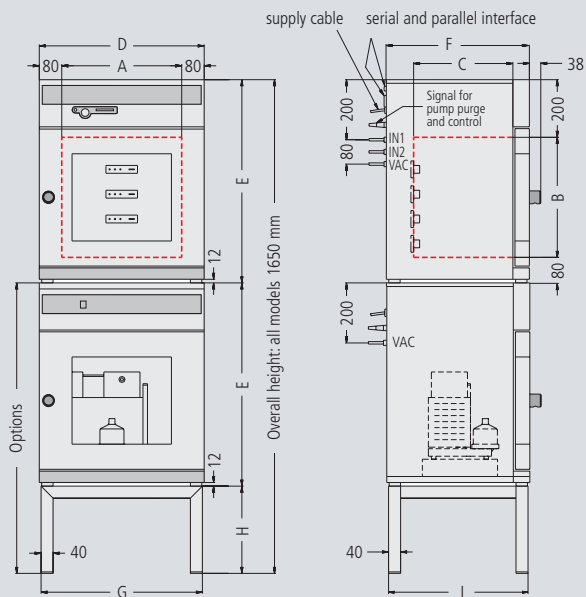

Model sizes		VO	200	400	500
Stainless steel interior (mat. 1.4404, electropolished)	Volume	approx. l	29	49	101
	Width / Height / Depth	(A) / (B) / (C) mm	385 / 305 / 250	385 / 385 / 330	545 / 465 / 400
	Max. number of thermoshelves	number	3	4	4
	Distance between thermoshelves	mm	75	75	95
	Maximum load per shelf / per oven	approx. kg	20 / 40	20 / 60	20 / 60
Usable area of thermoshelf: width / depth	mm	365 / 230	365 / 310	525 / 380	
Stainless steel exterior (rear zinc-plated steel)	Width	(D) mm	550	550	710
	Height	(E) mm	600	680	760
	Depth (without door handle, depth of handle 38 mm)	(F) mm	400	480	550
	Safety glass door: Textured stainless steel frame with spring-loaded safety glass on inside and anti-splinter screen ESG on outside of door		<input type="checkbox"/>	<input type="checkbox"/>	<input type="checkbox"/>
Door seal	Endless Silicone profile seal		<input type="checkbox"/>	<input type="checkbox"/>	<input type="checkbox"/>
Temperature	Electronic microprocessor temperature controller with Pt100 and auto-diagnostic system		<input type="checkbox"/>	<input type="checkbox"/>	<input type="checkbox"/>
	Temperature sensor Pt100 Class A in 4-wire circuit individually for each thermoshelf		<input type="checkbox"/>	<input type="checkbox"/>	<input type="checkbox"/>
	Temperature range	° C	from +20 up to +200	from +20 up to +200	from +20 up to +200
	Temperature variation in time (to DIN 58 945)	° C	≤ ± 0,3	≤ ± 0,3	≤ ± 0,3
	Temperature uniformity (surface) at 160°C / 50 mbar	° C	≤ ± 5	≤ ± 5	≤ ± 5
Pressure (vacuum)	Digital electronic pressure control (in programme operation up to 40 ramps, adjustable for each segment) for vacuum via solenoid valves (tubing and valves for vacuum, air and inert gas are made of material 1.4571). Adjustable from 10 mbar up to 1100 mbar. Digital display of actual pressure from 5 mbar up to 1100 mbar. Two programmable, alternatively selectable and digitally controlled inlets (for air and inert gas). Integrated drying process control with programmable vacuum cycles for a speeded-up moisture reduction. Signal for Memmert pump module (ON/OFF, purging)		<input type="checkbox"/>	<input type="checkbox"/>	<input type="checkbox"/>
	Rapid air intake for door opening without alteration of selected vacuum setpoint		<input type="checkbox"/>	<input type="checkbox"/>	<input type="checkbox"/>
	Permitted final vacuum	mbar	0,01	0,01	0,01
	Maximum leakage rate	bar / h	0,01	0,01	0,01
	Monitor	Microprocessor temperature monitor acting as overtemperature protection, incorporating fault diagnostics with visual and acoustic alarm		<input type="checkbox"/>	<input type="checkbox"/>
Digital overtemperature monitor			<input type="checkbox"/>	<input type="checkbox"/>	<input type="checkbox"/>
Digital undertemperature monitor			<input type="checkbox"/>	<input type="checkbox"/>	<input type="checkbox"/>
Temperature monitoring band automatically linked to the setpoint (ASF)			<input type="checkbox"/>	<input type="checkbox"/>	<input type="checkbox"/>
Multi-Level-Overtemperature-Protection (MLOP) for each thermoshelf			<input type="checkbox"/>	<input type="checkbox"/>	<input type="checkbox"/>
Relay for reliable heating cut-off in case of fault			<input type="checkbox"/>	<input type="checkbox"/>	<input type="checkbox"/>
Mechanical temperature limiter (TB)			<input type="checkbox"/>	<input type="checkbox"/>	<input type="checkbox"/>
Acoustic alarm: Over- and undertemperature		<input type="checkbox"/>	<input type="checkbox"/>	<input type="checkbox"/>	

Model sizes		VO	200	400	500	
Timer functions	Real-time/weekly programmer with group function (e.g. every weekday)		<input type="checkbox"/>	<input type="checkbox"/>	<input type="checkbox"/>	
	Timer with residual running time: max. 40 ramps (each 1 min. up to 999 h) programmable through controller or MEMoryCard XL; programming via PC and free-of-charge software: unlimited number of ramps		<input type="checkbox"/>	<input type="checkbox"/>	<input type="checkbox"/>	
Documentation	Internal log memory 1024 kB as ring memory for all setpoints, actual values, errors, settings with real time and date; capacity approx. 3 months at 1 min. intervals		<input type="checkbox"/>	<input type="checkbox"/>	<input type="checkbox"/>	
	Parallel printer interface for printing documentation data, suitable for all PCL3-compatible ink jet printers (USB available via converter, see options)		<input type="checkbox"/>	<input type="checkbox"/>	<input type="checkbox"/>	
	"Celsius 2007" ¹⁾ software for control and documentation of temperature and pressure		<input type="checkbox"/>	<input type="checkbox"/>	<input type="checkbox"/>	
Setup	Calibration (no separate PC required), temperature and pressure: 3-point calibration on controller		<input type="checkbox"/>	<input type="checkbox"/>	<input type="checkbox"/>	
	Setting of language for dialogue and display D / UK / E / F / I		<input type="checkbox"/>	<input type="checkbox"/>	<input type="checkbox"/>	
Connections	Vacuum connection with additional small flange DN16, two additional gas connections with small flange DN 16 (air, inert gas)		<input type="checkbox"/>	<input type="checkbox"/>	<input type="checkbox"/>	
Further data	Electrical supply ²⁾	V / Hz	230 / 50/60	230 / 50/60	230 / 50/60	
	Electrical load (loading with max. number of thermoshelves)	approx. W	1200	2000	2400	
	Net weight / Gross weight	approx. kg	58 / 64	82 / 90	120 / 134	
Standard accessories	Removable interior mounting (stainless steel material 1.4404) with integrated lateral guide bars for thermoshelves		<input type="checkbox"/>	<input type="checkbox"/>	<input type="checkbox"/>	
	Thermoshelves (stainless steel material 1.4404) with integrated large-area heating including local temperature sensing (Pt100, 4-wire-circuit); individual overtemperature protection for each shelf. Further data see stainless steel inner working chamber	number	1 <input type="checkbox"/>	2 <input type="checkbox"/>	2 <input type="checkbox"/>	
	Removable bottom drip tray (stainless steel material 1.4404)		<input type="checkbox"/>	<input type="checkbox"/>	<input type="checkbox"/>	
	Works calibration certificate (measuring point in the middle of the individual shelf for 160 °C at 50 mbar pressure): a separate certificate is prepared for each thermoshelf ordered and shipped together with the vacuum oven		<input type="checkbox"/>	<input type="checkbox"/>	<input type="checkbox"/>	
Standard version	Vacuum Oven VO		VO 200	VO 400	VO 500	
Options	Additional thermoshelves stainless steel material 1.4404 (when ordered and shipped together with the vacuum oven incl. calibration certificate)		E8(x)	E8(x)	E8(x)	
	Computer interface RS485 (for networking a maximum of 16 ovens) instead of RS232 interface		○ / V2	○ / V2	○ / V2	
	Parallel/USB converter cable with integral plug-in power supply for connection of HP printers with USB port to MEMMERT equipment. Compatible with USB 1.1 and USB 2.0		W1	W1	W1	
	Documentation package, consisting of parallel/USB converter cable and matching PLC3-compatible HP ink jet colour printer with USB connection (HP Deskjet 5940 or successor model) for direct connection of the printer to Memmert equipment		W2	W2	W2	
	Connection cable for computer interface RS232 according to DIN 12 900-1		V6	V6	V6	
	Flexible Pt100 for positioning in chamber of vacuum oven or in load with the socket in the front control panel, 4-pin according to NAMUR NE 28 for external temperature recording (load temperature)		H4	H4	H4	
	Works calibration certificate for 3 temperatures 50 °C, 100 °C, 160 °C at 50 mbar pressure		Z6	Z6	Z6	
	Temperature profile write/read unit for programming via PC, for writing to and reading from the chip card, up to 40 ramps		V3	V3	V3	
	Additional chip card, blank, formatted (32 kB MEMoryCard XL for a maximum of 40 ramps)		V4	V4	V4	
	Oven-linked authorisation card (User-ID-Card) prevents undesired manipulation by unauthorised third parties		V1	V1	V1	
	IQ check list with works test data for oven as support for validation by customer		Q1	Q1	Q1	
	OQ check list (one free-selectable thermoshelf temperature distribution survey with 5 measuring points) ³⁾ with works test data for oven as support for validation by customer		Q2	Q2	Q2	
	Software "Celsius 2007 FDA Edition" ⁴⁾ meets the requirements for the use of electronically stored data sets and electronic signatures as laid down in Regulation 21 CFR Part 11 of the US Food and Drug Administration (FDA)		Q3	Q3	Q3	
Pump module	Noise-insulated vacuum pump module <u>without pump</u> (dimensions and material of exterior see vacuum oven) with antivibration metal plate at the bottom to accommodate the vacuum pump, including full-sight glass door. Socket, signal cable and connecting hose to the vacuum oven		PM 200	PM 400	PM 500	
	Ditto, <u>with built-in pump</u> , 230 V, 50/60 Hz ²⁾ including energy-saving pump control (pump K5 for VO 200 and pump K6 for VO 400 and VO 500)		PMP 200	PMP 400	PMP 500	
	Net weight	without / with pump	approx. kg	26 / 40	30 / 45	41 / 56
	Gross weight	without / with pump	approx. kg	32 / 46	38 / 53	57 / 69
Options	Chemically resistant vacuum pump ⁵⁾ with PTFE double diaphragm, pump capacity at atm. pressures: approx. 34 NI/min. = 2,04 m ³ /h and autom. purge control from vacuum oven. Order No. V7 + V8 are essential. 230 V ²⁾ , 50/60 Hz		K5	–	–	
	Ditto, with pump capacity at atm. pressures: approx. 60 NI/min. = 3,6 m ³ /h		–	K6	K6	
	Signal cable (3 m) for optimising pump performance by demand-controlled activation of purge of Memmert pump ⁶⁾		V7	V7	V7	
	Vacuum connecting hose (3 m) from oven to Memmert pump incl. optimised connection accessories (partially stainless steel) ⁶⁾		V8	V8	V8	
	Subframe	Tubular steel, black enamelled, (for stacking unit consisting of vacuum oven and pump module, total height: 1650 mm, see sketch on top of left page)		G5	G5	G5
	Width / Height / Depth	(G) / (H) / (I)	mm	529 / 450 / 383	529 / 290 / 463	689 / 130 / 533

Subject to technical modifications

standard model, basic specification

special equipment at no extra cost

– not available

(x) Please specify quantity required after the order number

1) MEMMERT "Celsius 2007" software has been tested for

Windows NT 4, 2000, and XP; in preparation for Windows Vista

2) other voltages upon request

3) further temperature distribution surveys at extra cost

4) requires Windows 2000 Professional or XP Professional

5) max. guarantee 2 years

6) not required when ordering pump module with pump

(or if it is already available)

OUR PROGRAMME

Universal ovens
Incubators
Hot air sterilisers
Ovens



Vacuum ovens



Peltier-cooled incubators
Compressor-cooled incubators
Cooled incubators



CO₂ incubators



Humidity chambers



Water and oil baths



Your Memmert Partner

Upon your request we are pleased to send you detailed brochures

memmert®

Memmert GmbH + Co. KG
P.O. Box 1720
D-91107 Schwabach
Germany
Tel. +49 (0) 9122 / 925 - 0
Fax +49 (0) 9122 / 145 85
E-Mail: sales@memmert.com

www.memmert.com

Some of the illustrations in this publication include special accessories. We reserve the right of technical modifications. Dimensions are subject to confirmation.